

**rogerseller**  
**ORGANICS**



**BATH LIFE STYLE**

**rogerseller**

**MELBOURNE**  
173-177 Barkly Avenue  
Burnley VIC 3121  
P 03 9429 8888 F 03 9429 6966

**SYDNEY**  
PYD Building  
197 Young Street  
Waterloo NSW 2017  
P 02 8396 8700 F 02 9690 2804

**BRISBANE**  
72-78 McLachlan Street  
Fortitude Valley QLD 4006  
P 07 3251 4333 F 07 3257 2155

**PERTH**  
153 Broadway  
Nedlands WA 6009  
P 08 6389 1366 F 08 6389 1466

**CONCEPT STORES**  
Southern Innovations  
Canberra ACT  
P 02 6126 1155 F 02 6126 1156  
Albury NSW  
P 02 6049 3355 F 02 6049 3356

Estilo Bathware & Ceramics  
Adelaide SA  
P 08 8415 2999 F 08 8415 2900

Vogue Spas & Bathrooms  
Southport QLD  
P 07 5528 0077 F 07 5528 0767

Gunns Kitchens & Bathrooms  
Launceston TAS  
P 03 6332 6201 F 03 6332 6299  
Hobart TAS  
P 03 6272 6899 F 03 6272 9088

.....

**COSMIC**

[rogerseller.com.au](http://rogerseller.com.au)

Dimensions are approximate. Information provided in this brochure is representative of the actual products available at the time of printing. Due to our policy of continuous product development, the designs and specifications depicted are subject to change without notice. Please confirm all particulars with your sales consultant prior to purchase. Each product is covered by a limited warranty. Full terms and conditions are available from your sales consultant.

# ORGANICS

Rogerseller presents an exciting new accessories range from Spanish designers Cosmic. Organics fuses natural shapes with elegant and sophisticated lines. Moving away from traditional sharp edges, the Organic shape is soft and fluid presenting a contemporary understated aesthetic.

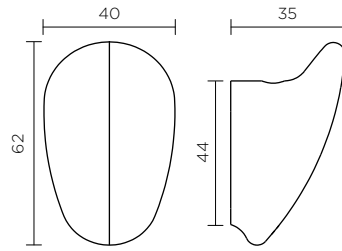

**ROBE HOOK**  
**428350** | Chrome  
 › 40 x 35 x 60mm  
 › Double fixing points

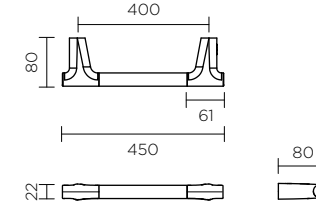

**TOWEL RAIL 450MM**  
**428358** | Chrome  
 › 450 x 80 x 20mm  
 › Single fixing points\*

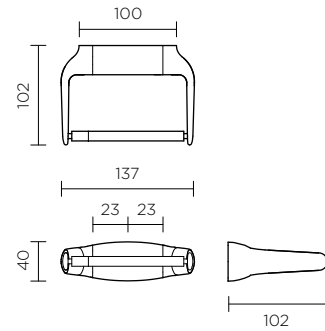

**PAPER HOLDER**  
**428352** | Chrome  
 › 137 x 102 x 40mm  
 › Triple fixing points

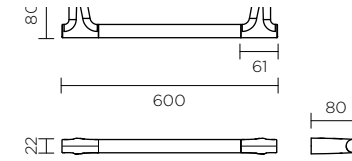

**TOWEL RAIL 600MM**  
**428360** | Chrome  
 › 600 x 80 x 20mm  
 › Single fixing points\*

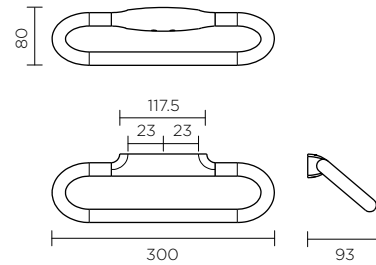

**HAND TOWEL RING**  
**428354** | Chrome  
 › 300 x 93 x 80mm  
 › Triple fixing points

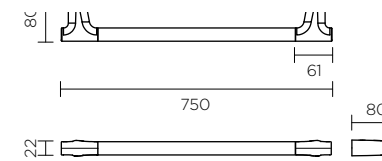
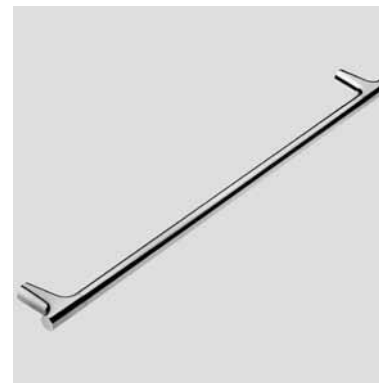

**TOWEL RAIL 750MM**  
**428362** | Chrome  
 › 750 x 80 x 20mm  
 › Single fixing points\*

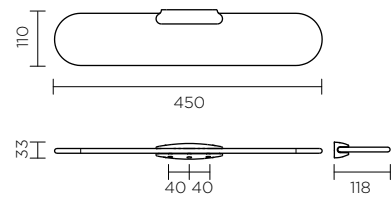
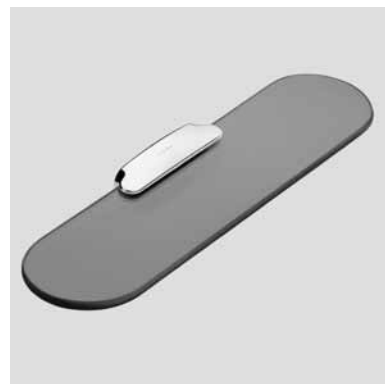

**SHELF 450MM**  
**428356** | Chrome  
 › 450 x 118 x 35mm  
 › Triple fixing points

\* Refer to installation instructions for fixing points.